

# Suur värav

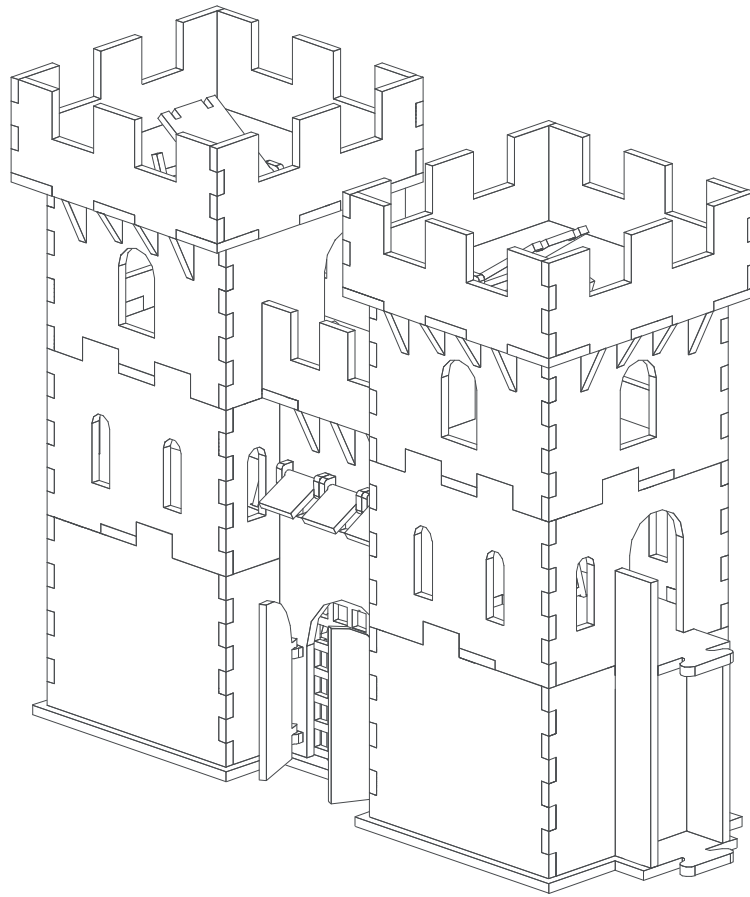

## Esimene korrus lk 1

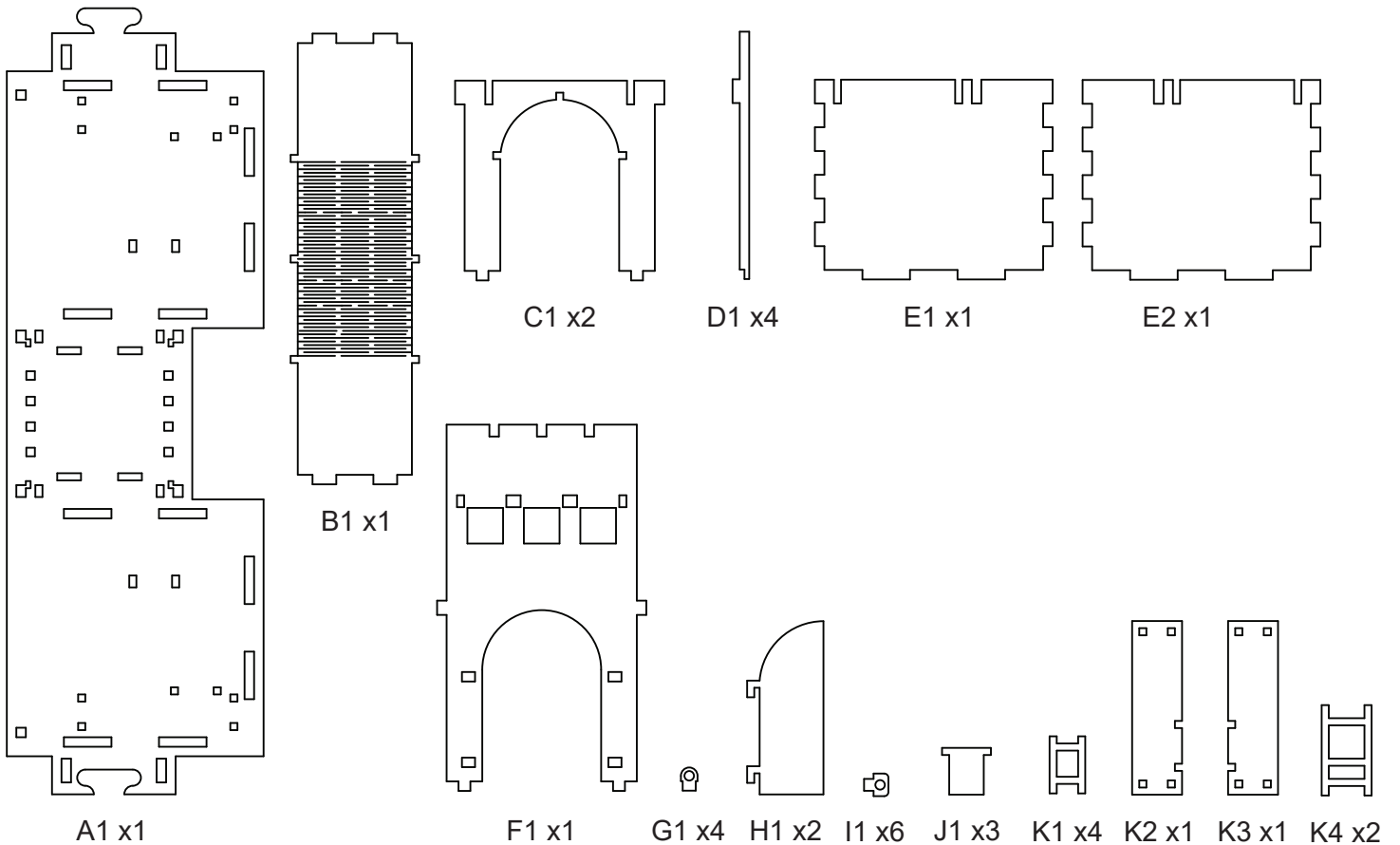

### Esimene korrus lk 2

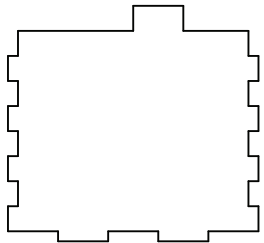

L1 x1

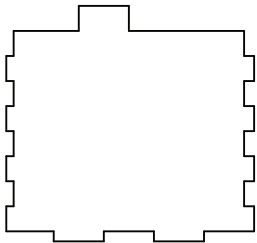

L2 x1

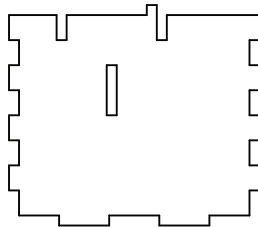

M1 x1

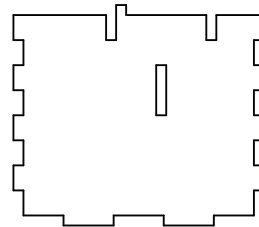

M2 x1

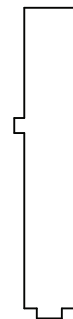

N1 x1

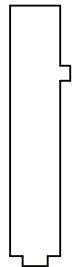

N2 x1

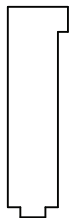

N3 x2



O1 x3

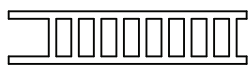

P1 x2

### Teine korrus

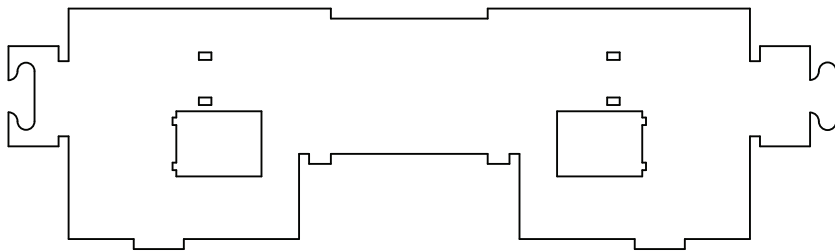

A2 x1

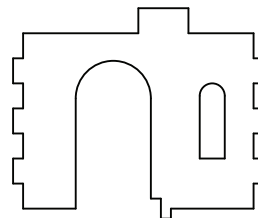

Q1 x1

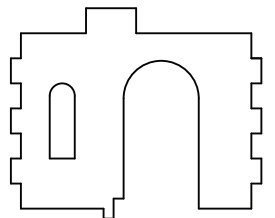

Q2 x1

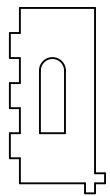

R1 x1

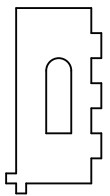

R2 x1

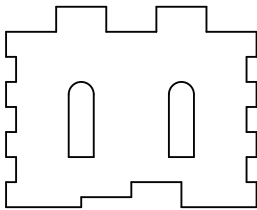

S1 x1

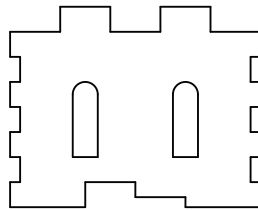

S2 x1

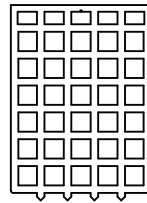

Š1 x2



Z1 x1

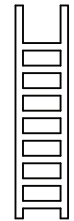

Ž1 x2

### Kolmas korrus lk 1

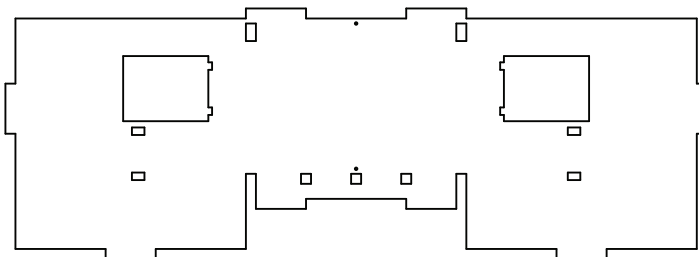

A3 x1

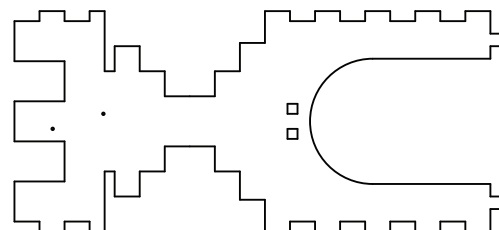

T1 x1

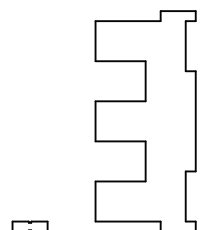

U1 x2

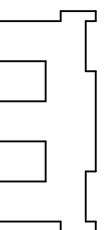

V1 x1

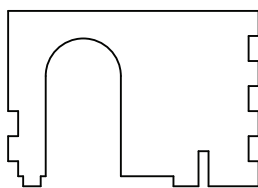

W1 x1

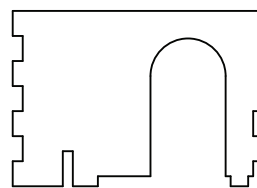

W2 x1

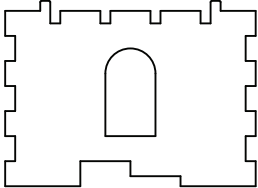

Õ1 x1

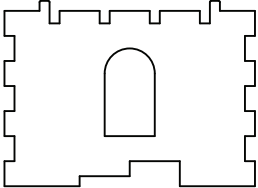

Õ2 x1

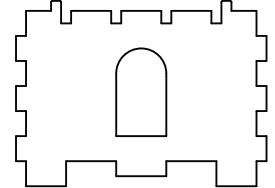

Ä1 x2

### Kolmas korrus lk 2

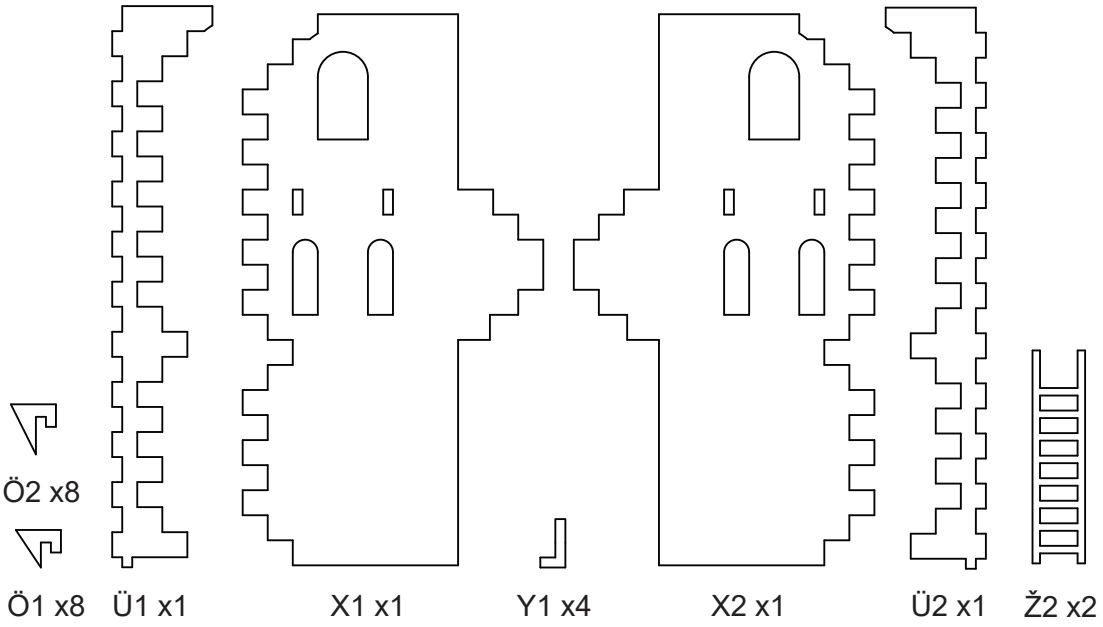

### Neljas korrus

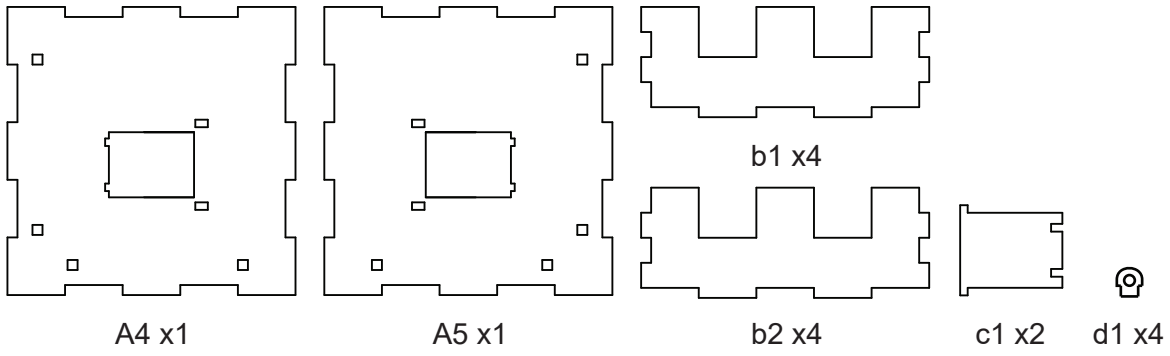

Soovitusi kokkupanekuks.

Enne detaili liimimist proovi seda  
joonisel näidatud kohale ilma liimita.  
Pane tilk liimi detailide kõikidele  
kokkupuutepindadele.  
Suru detailid korralikult teineteise  
vastu ja vajadusel hoia neid mõnda  
aega omavahel koos.  
Kui detailil on muster ühel küljel,  
säti see väljapoole.

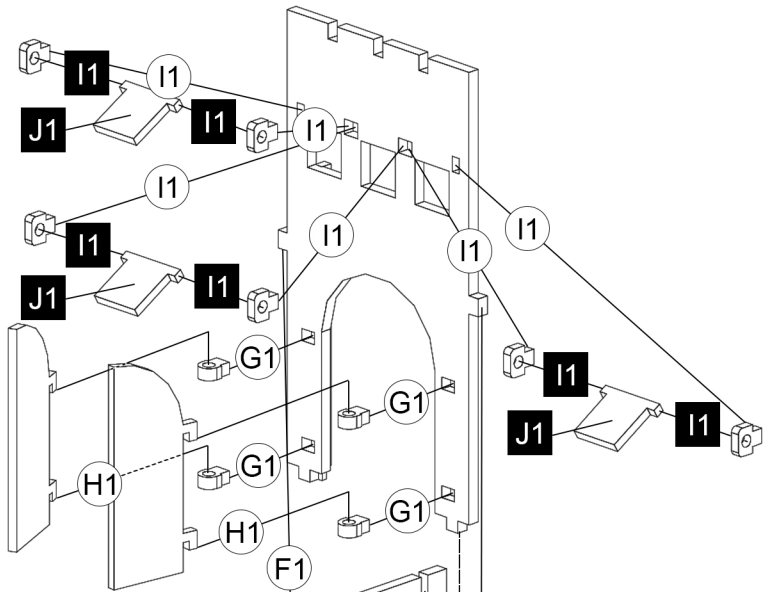

○ - liimi detail

■ - ära liimi detaili

⊕ - sõlmi

1 - A1

2 - B1

3 - C1, C2

4 - D1 x4

5 - E1, E2

6 - F1

7 - G1 x4

8 - H1 x2 = ■

9 - I1 x6, J2 x 3 = ■

9.1 - (I1 x6, J2 x 3), F1

10 - K1 x4, K2, K3, K4 x2

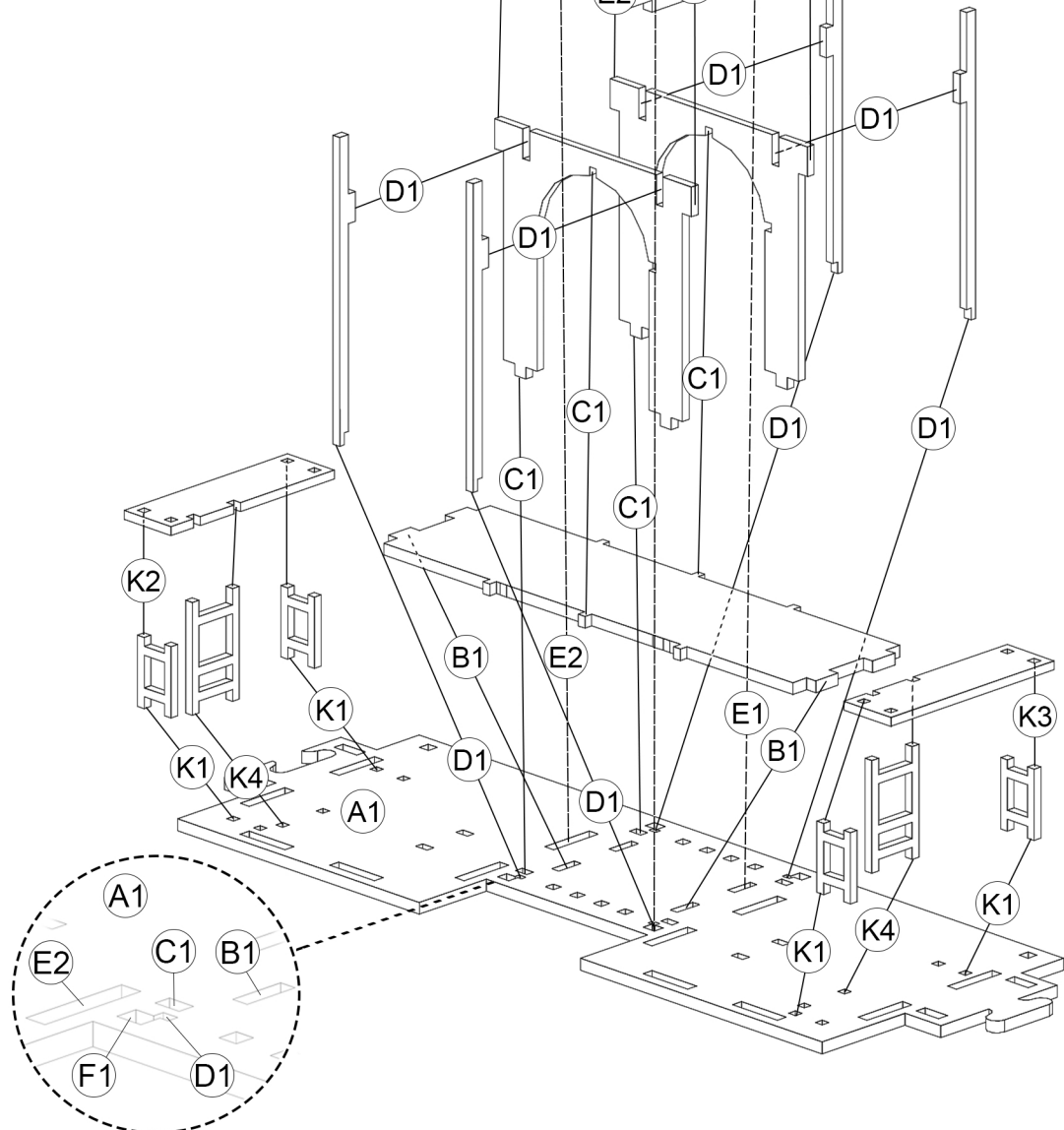

11 - L1, L2, M1, M2

12 - N1, N2, N3 x2

13 - O1 x3

14 - P1 x2 = 

15 - A2 = 

16 - Q1, Q2, R1, R2, S1, S2

17 - Š1 x2 + Z1 x2 → A3

18 - A3

19 - Ž1 x2 = 

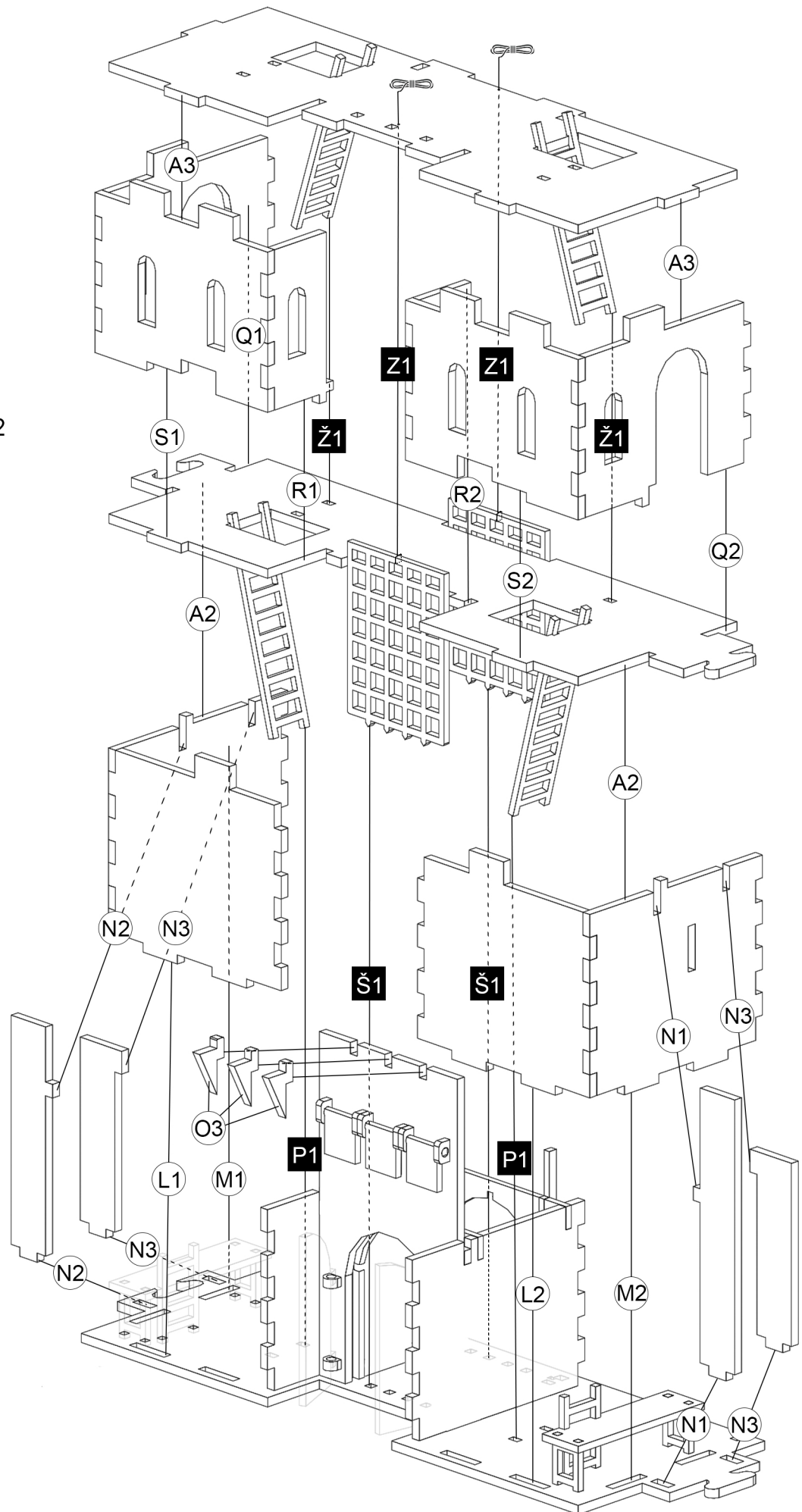

20 - T1

21 - (Š1 x2 + Z1 x2 → A3) → T1+U1

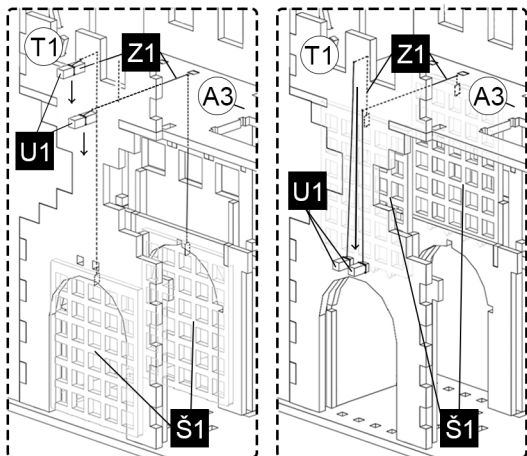

22 - V1

23 - W1, W2, Ö1, Ö2, Ä1 x2

24 - Ö1 x8, Ö2 x8

25 - Ü1, Ü2

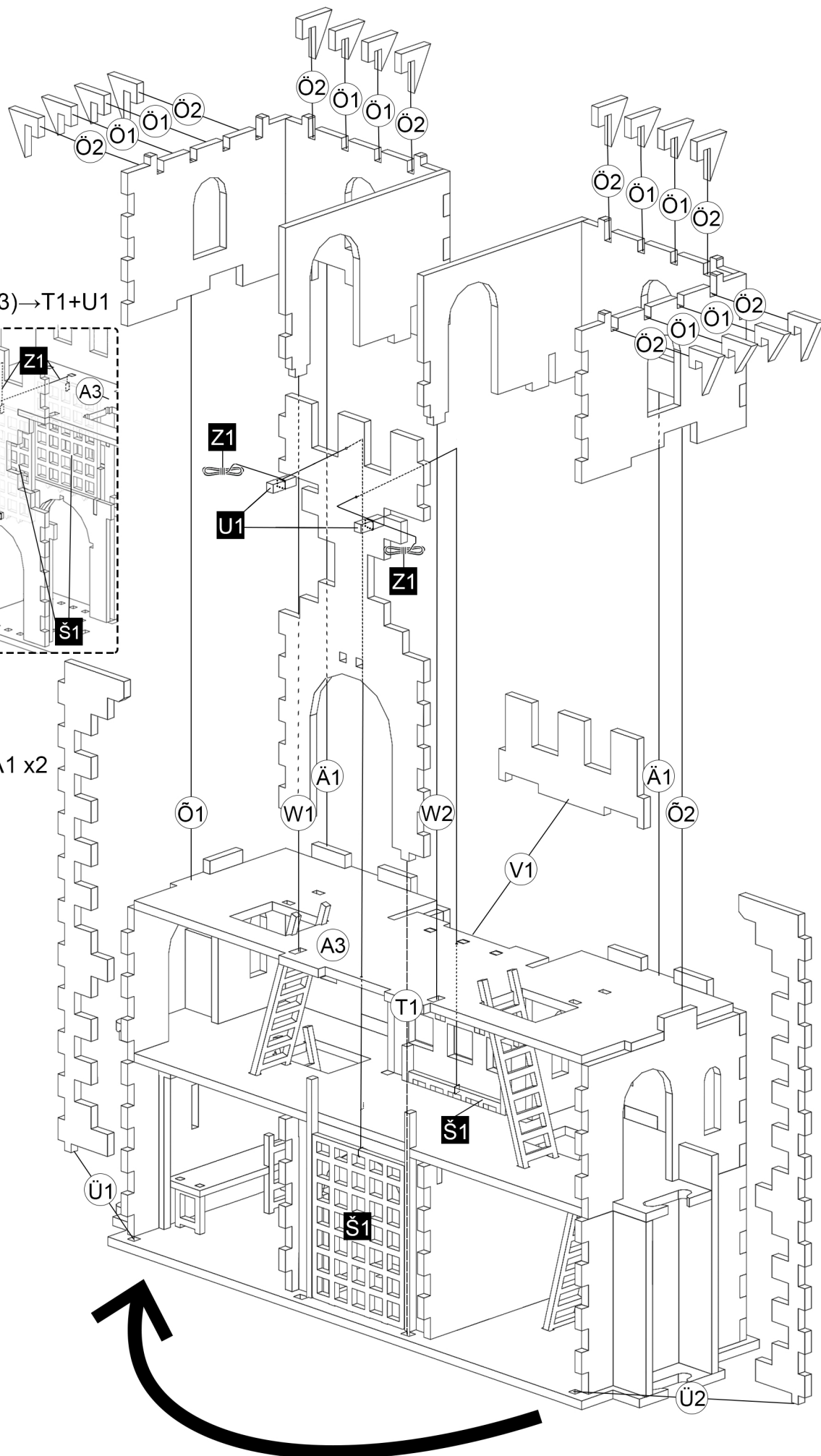

26 - X1, X2, Y1 x4

26.1 - (X1, X2, Y1 x4) = Ü1, Ü2, T1

27 - A4, A5

28 - Ž2 x2

29 - b1x 4, b2 x4

30 - c1 x2, d1 x4 = ■

30.1 - (c1, d1 x2), A4

30.2 - (c1, d1 x2), A5

Toredat mængimist !

